

# PAB-SE Economical Barrier Gate

**Dashou**  
Parking System Expert



Fence arm

Folding arm

Swing off arm

Color optional

**PAB-SE Economical** series boom barrier adopts free-maintenance brushless DC motor and PWM variable frequency controller. Opening/closing time is 0.9~6s adjustable. Incredible 5 million MTBF makes the barrier always works well with long life span. Its boom direction is quickly exchangeable, boom type (straight/folding/fence) can be changed at site without replacing any parts. Telescopic straight arm is also available which help you reduce shipping cost. .

### Free-maintenance Brushless DC Motor 5 million cycles MTBF

Free-maintenance brushless DC24V motor ensures 5 million MTBF long life span; Max. 100W low consumption makes barrier environment friendly but outputs super strong torque

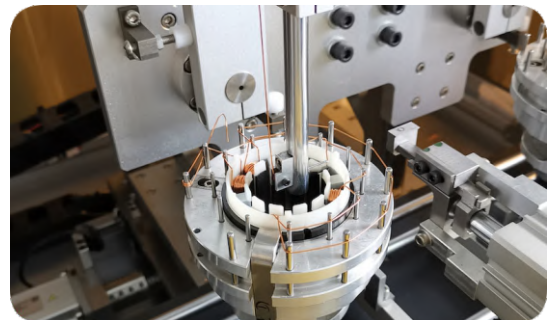

### Boom Direction Is Exchangeable Without Replacing Any Parts

In the past you have to keep stock for barriers with different boom direction as different sites may require different boom direction. But now boom arm direction can be exchanged easily at site without replacing any parts

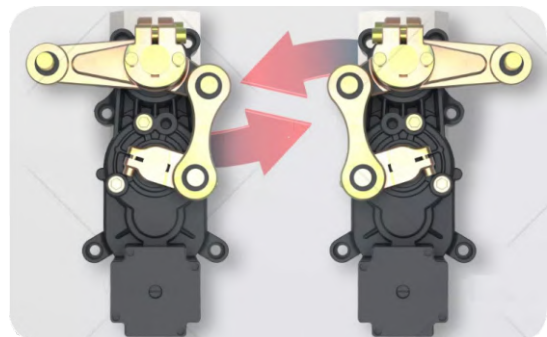

Leftward

Rightward

## Boom Swing-off Protects Boom and Vehicle

Boom will swing off 90 degree if it was hit by a vehicle, this is to protect both vehicle and boom. It is optional. You can easily add swing-off module to a barrier which is without swing-off.

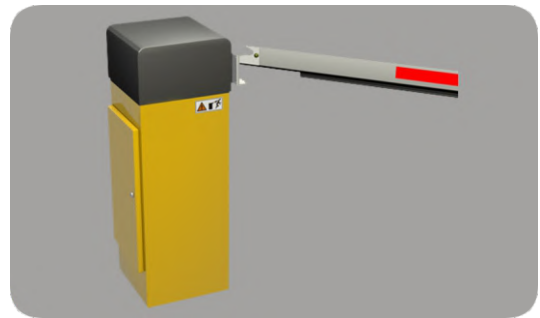

## Boom Auto-Reverse On Obstacle

While moving down, boom will automatically reverse immediately once it is obstructed by vehicle or pedestrian, which protects the vehicle or person. The sensitivity is adjustable.



## Manually Control In Case of Power Failure

If power supply is off, you can manually open/close the barrier gate by the black lever. Also boom can be manually locked in any position between horizontal and vertical by this level.

Warning: Not allowed to use the function when power on, may hurt your hand and damage the motor.



## 0.9~6 Second Speed Adjustable

The barrier gate adopts digital frequency servo controller, which allows the stepless speed control of the drive motor under the condition of no loss of output torque, and the opening/closing time can be respectively adjustable between 0.9s, or 2~3s or 3~6s.





### Backup Solar Panel or Lead-acid Cell

DC motor barrier can be powered by solar panel or lead-acid cell for back up power supply. Especially solar power is environment friendly which is good for earth.



### LED Illumination Makes Boom Visible In The Night

LED Illumination bar can be installed onto boom to make boom visible in the night, so that drivers can view barrier and boom clearly, this improve safety of both barrier and vehicle. Also LED decorates barrier gate.

### More Features

1. 0.9s, or 2~3s adjustable, or 3~6 sec. adjustable on controller
2. Smooth moving with Max. 6m boom
3. Different types of boom can be changed without replacing any parts
4. Boom automatically open up fully in case of power failure (Optional)
5. Safety of Vehicle--- Anti-hit by Loop Detector (Optional)
6. Safety of Vehicle--- Anti-hit by IR photocell (Optional)
7. Safety of Vehicle--- Anti-hit by "Opening Priority"
8. Automatically close in given time (Programmable)
9. Automatically close or open by loop detector (Optional)
10. Enable or disable "Always-open Mode" on remote (Optional)

## Dimension (mm) Application

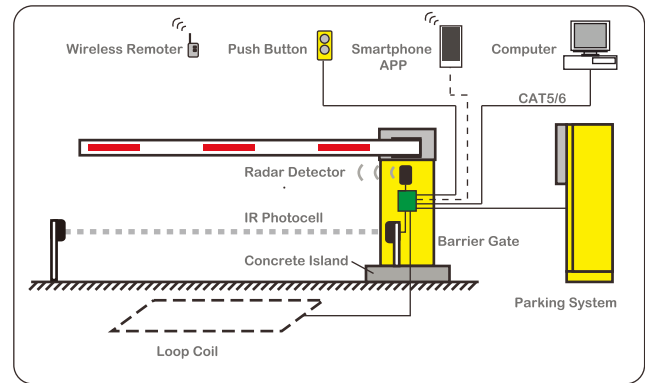
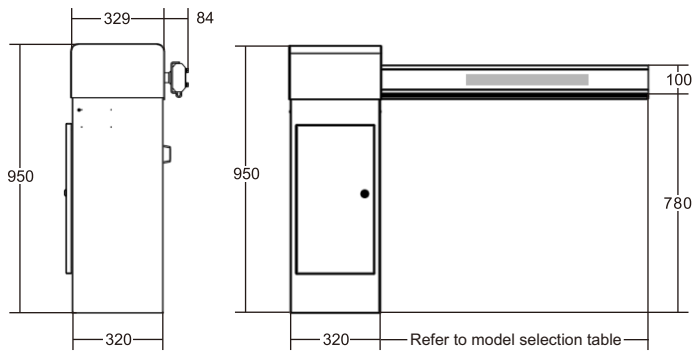

## Technical Parameter

<b>Close/open time</b>	0.9s, or 2~3s adjustable, or 3~6 sec. adjustable
<b>Boom</b>	Max. 6mtr. 86×44mm Aluminum alloy Octagonal boom
<b>Boom</b>	Telescopic straight arm optional
<b>Boom Direction</b>	Leftward / rightward exchangeable
<b>Power Supply</b>	AC220V or AC110V, 50/60Hz
<b>Motor</b>	100W DC24V brushless servo motor
<b>Duty Cycle</b>	Less than 100% duty cycle
<b>MTBF</b>	5 Million Cycles (Meantime Before Failure)
<b>Controller</b>	PWM variable frequency servo controller board
<b>Wireless Remote</b>	Two Remoters, distance>20m

<b>Communication Interface</b>	RS-485
<b>Spring</b>	1~2 pcs spring according to boom length
<b>Housing Material</b>	1.5mm cold-roller sheet
<b>Housing Painting</b>	Powder coating last 10 years
<b>Protection Rating</b>	IP 54
<b>G.W / N.W</b>	48/46KG
<b>Package Dimension</b>	1100×430×480mm (H*W*D)
<b>Product Dimension</b>	950×320×329mm (H*W*D)
<b>Operating Temperature</b>	-30°C~70°C
<b>Operating Humidity</b>	10%~95%

## Accessories

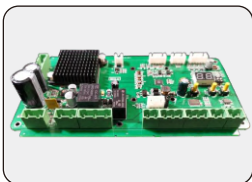

PWM variable frequency servo controller board



Remoter: transmitter, distance>20m

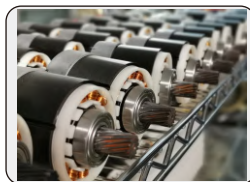

100W DC24V Brushless Servo Torque Motor



Auto-open Module



Reserved



Aluminum Alloy Round Boom with Foam



86×44mm Aluminum Alloy Octagonal Boom with Rubber Bar

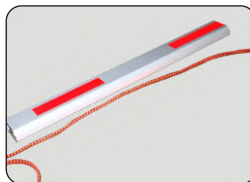

Arm With LED light bar: Green/red, DC12V power

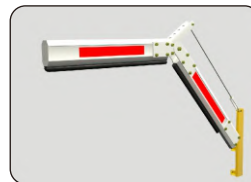

Articulated arm



Fence arm



Boom Arm Bracket

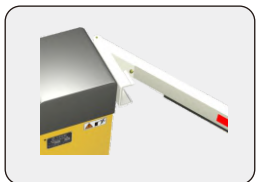

Swing-off

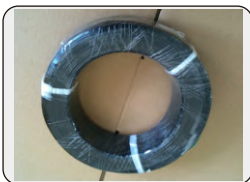

Ground Induction Coil



Loop Detector



Photocell